

V40-BK SERIES

V40SGEBK
V40BVCBK
V40SG2EBK
V40DG2EBK

UNDERBENCH INSTALLATION INSTRUCTIONS

These units are not designed for outdoor use – please see conditions at the end of this information.

1. Cabinet dimensions: BK

Height 820mm – 860mm (40mm adjustable feet) Width 595mm

Depth 562mm + 30mm stopper (=592mm)

2. This cabinet is not designed to be fully integrated behind a joinery door.

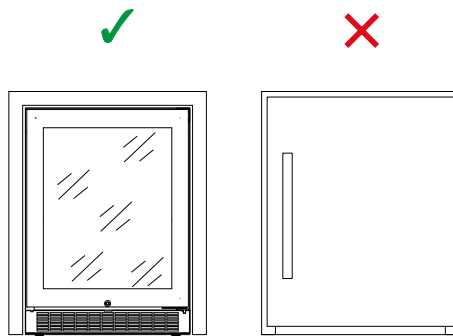

3. Please note that a minimum cut out of 615mm is required to facilitate installation, removal and servicing.

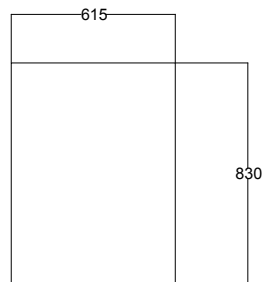

4. This cabinet requires 10mm clearance on both sides and 30 mm at the top and 30mm clearance at the rear. A ventilation grid **MUST** be installed in the 30mm clearance at the rear. Because hot air rises it is imperative that a grille with a Minimum grid size of 200mm x 40mm is installed at the top of the back wall or on either side at the rear at the top giving cool fresh air full access to flow into the 30mm gap at the rear of the cabinet. This means that you must not install the grille close to other appliances such as an oven or to an area that is sealed or with out access to fresh cool air. (You **MUST** call the Vintec Service Department on 1800 771 776 if you do not understand any part of this statement. Failing to comply with the above specifications could result in **WARRANTY** void.)

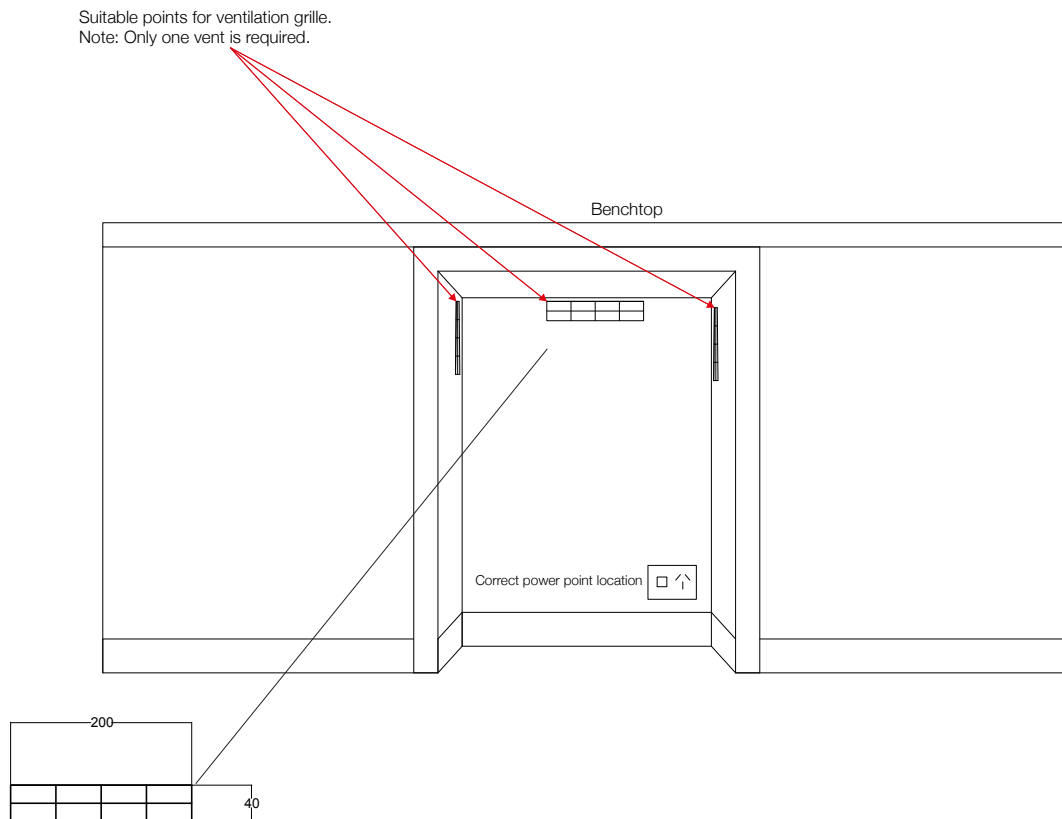

5. This cabinet is front venting. The cabinet draws air from the rear and expels through the grille under the door at the front. If a kick board is to be placed in front of the ventilation grille at the front a grille must be fitted in to the kick board with a minimum air flow allowance of 150cm².

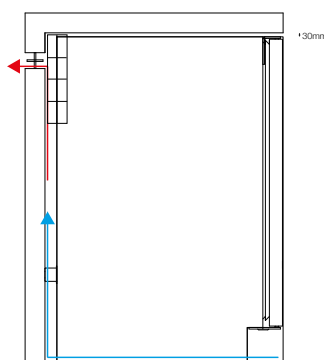

6. This cabinet has a power switch located on the control panel so powerpoint location is not critical.

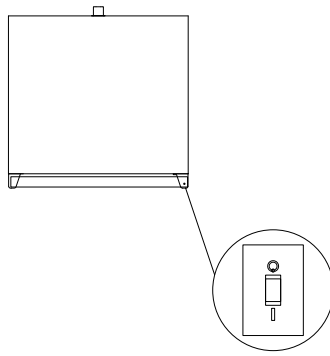

7. This cabinet requires a standard 240 volt/10 amp power point.

8. The power cord is 1.9m in length and is fixed on the right side at the back when looking from front of cabinet.

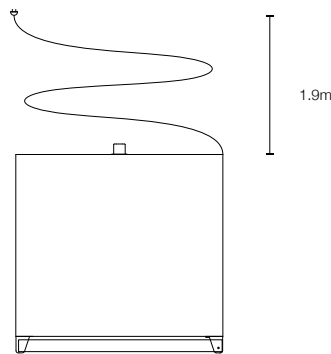

9. As with most appliances of today, this cabinet has sensitive electronic components which are susceptible to damage through lightning and electricity supply faults. It is therefore advised to use a power surge protector to avoid problems of this nature and to avoid piggybacking with other appliances.

Further Instructions:

The location you have selected for your wine cellar should:

- be unencumbered and well ventilated;
- be well away from any heat source and direct sunlight;
- not be too damp (laundry, pantry, bathroom etc.);
- have a flat floor,
- have a standard and reliable electricity supply (standard socket to country standards, linked to the ground), it is NOT recommended to use a multi-socket or extension lead.
- have a surge protector fitted to the electrical outlet away from the microwave.

Certain microwave ovens do not have wave interference shield. When placed within a 1 meter vicinity of the wine cabinet, they may affect the operation of the wine cabinet.

OUT DOOR USE

Please note that, whilst Vintec units are not designed for outdoor use they can be placed in certain Al Fresco areas but they **MUST** be well undercover – **NEVER** exposed to sunlight or the elements.

These units have glass doors & must not be situated where they are exposed to sunlight or reflected sunlight. In areas of high humidity there will be condensation on the glass doors. The units must be under significant cover & removed from any heat source (BBQ etc)

The ventilation requirement indicated for indoor use must be increased when situated outdoors by at least 2 cm on both sides & 3cm on top, 3 cm at the back with a large vent at the top of the back wall to facilitate heat evacuation. Because hot air rises it is imperative that a grille with a Minimum grid size of 200mm x 40mm is installed at the top of the back wall or on either side at the rear at the top giving cool fresh air full access to flow into the 30mm gap at the rear.

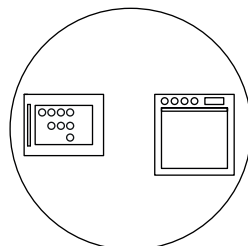
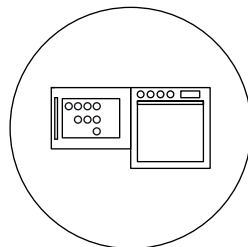
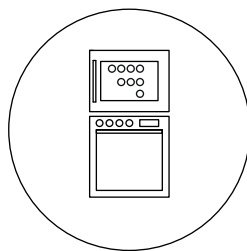
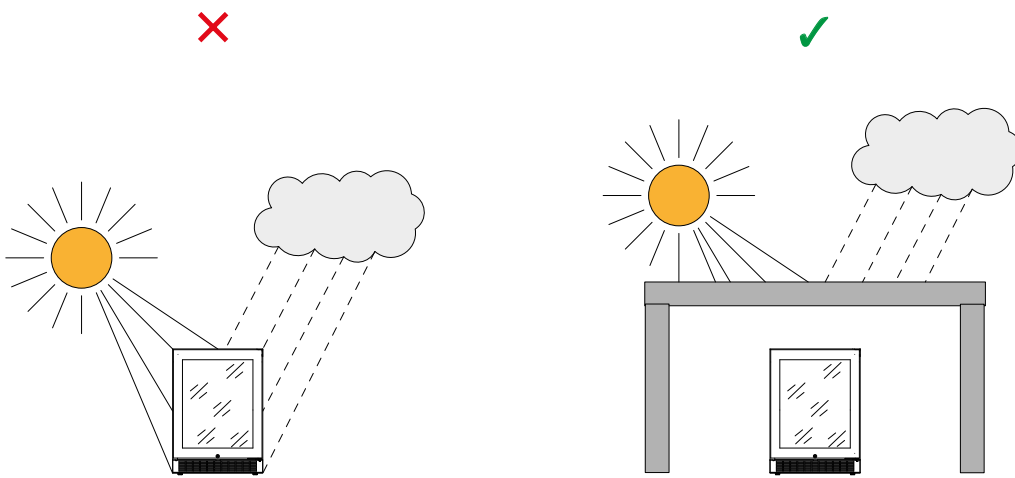

ONE OR MORE UNITS

The V40 Range can be installed next to each other in a row. All installation instructions should be followed.

The BK range has no handle and is opened by putting fingers on the top edge of the door frame. When installing the BK range in a row ensure there is a minimum gap of 10mm between each unit.

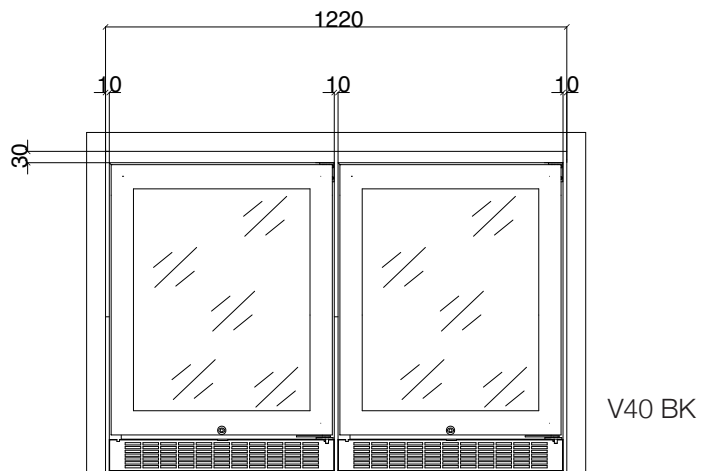
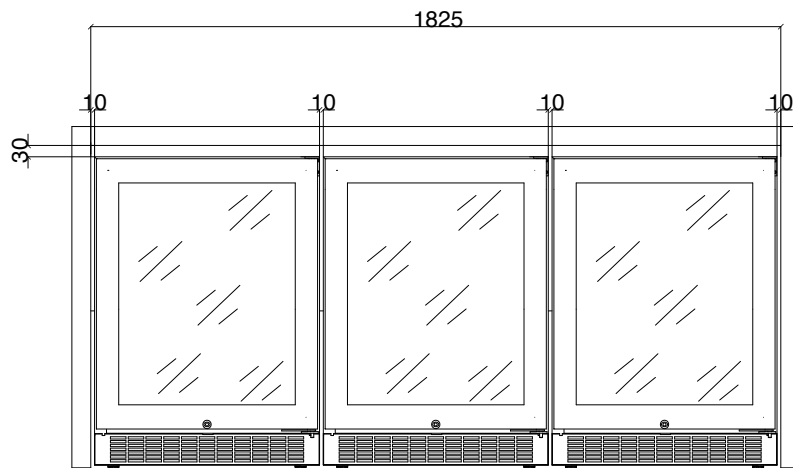

Notes:

- V40 models are built-in type as per the drawings hereafter;

The wine cellar should be placed where the ambient temperature is between 5°C to 35°C. If the ambient temperature is above or below this range, the performance of the unit may be affected. Placing your unit in extreme cold or hot conditions may cause interior temperatures to fluctuate. The ideal range of temperature may not be reached.

Not complying with any of the above instructions may result in WARRANTY void.

Vent Specifications

Suitable points for ventilation grille.
Note: Only one vent is required.

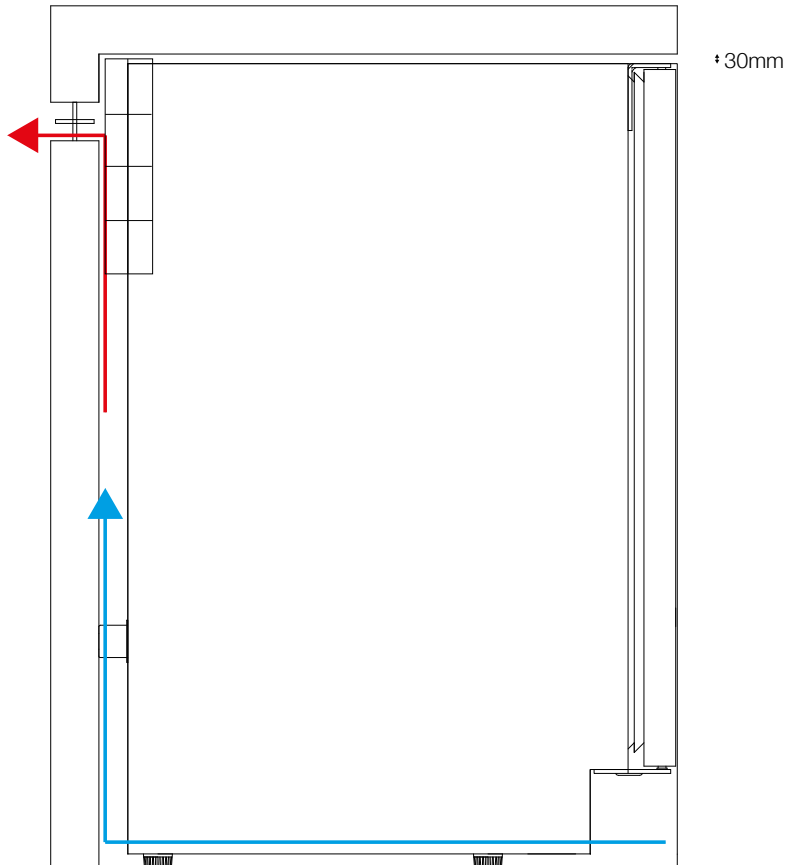
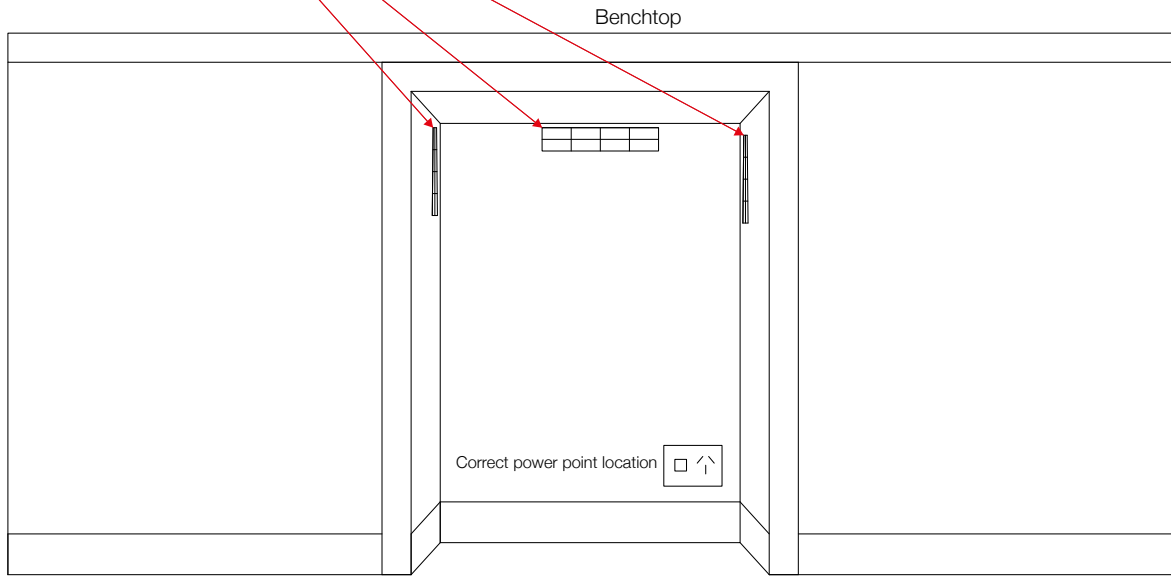

V40 BK Installation Dimensions

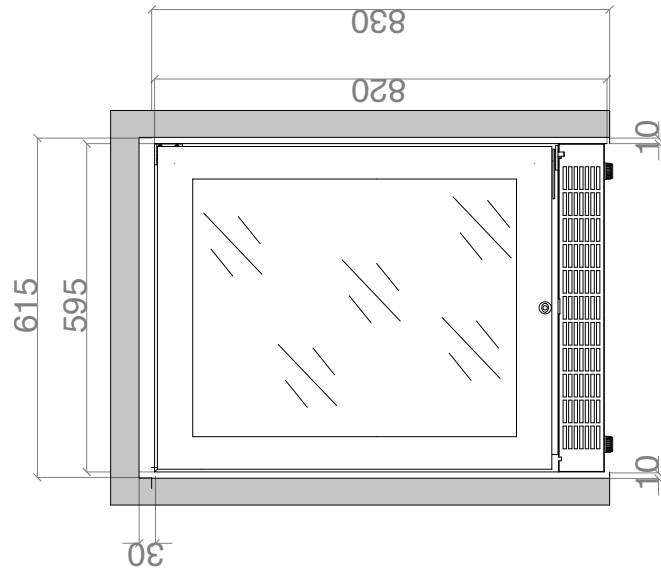

Front Elevation

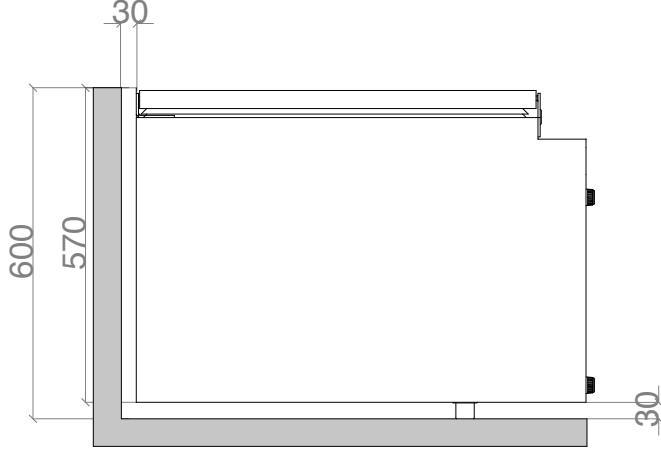

Side View

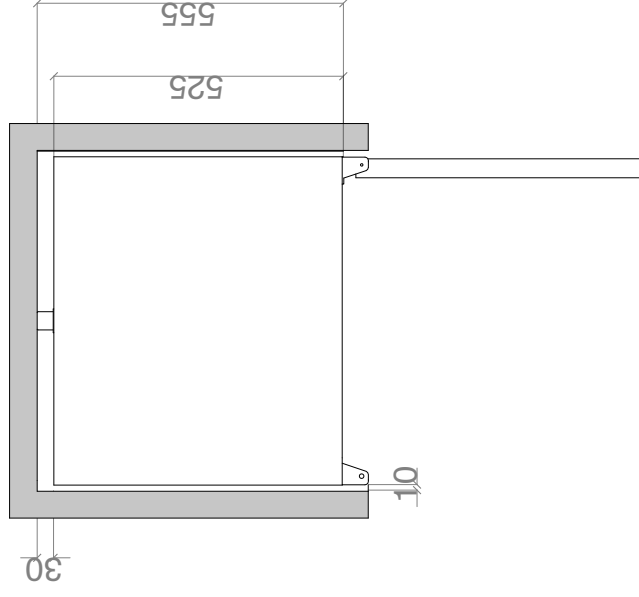

Top View